

ISO 9001

OSS Series

AUTOMATIC TRANSFER SWITCHES

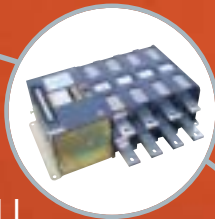

SMALL



STRONG



SAFETY



SMART



O-Sung Electric Machinery CO., LTD.

Safety Manual | 안전 주의서

Safety Notice

These safety notices are followed by important safety information. Be sure to read these notices, product instruction and other related information throughly to familiarize with product handling, safety information and all other precautions before installation or maintenance.

이 주의서는 안전에 관한 중요한 내용을 기술하였습니다.

ATS 취급작업에 앞서 반드시 이 주의서 및 부속된 취급설명서와 기타 부속서를 전부 읽어보시고 올바르게 사용하여 주십시오. 기기의 지식, 안전의 정보 그리고 주의사항의 모든 것을 습득한 뒤 사용하십시오.



Danger 위험

Emergency situation, which may cause death or serious disaster if there is mistake.

취급을 잘못했을 경우 사망 또는 중대한 재해가 발생할 수 있는 급박한 상황



Caution 주의

A potentially problematic situation, which may cause slight personal injury and/or damage.

취급을 잘못했을 경우 약한 정해나 경상을 야기할 수 있는 잠재적 상황

These safety notices are divided as "Danger" and "Caution" according to the hazard level.

이 주의서에는 안전주의사항의 Level을 위험정도에 따라 「위험, 「주의로 구분하고 있습니다.



Caution 주의

- Do not enter the area under the Automatic Transfer Switches (ATS) when it is lifted or suspended using a lifter or chain block. The ATS may suddenly drop. **The ATS is heavy. Entering such an area may cause serious injury.**
- Lifter로 들어올리거나 Hoist 등으로 고정하여 들어올릴 때는 ATS의 아래에는 절대 들어가지 마십시오. ATS는 제품의 중량에 따라 낙하시 위험을 초래할 수 있습니다.



Caution 주의

- Installation should be performed by qualified persons.
- Prior to commencing any installation, open the upstream circuit breaker to isolate all power/voltage sources. **Otherwise, electric shock may occur.**
- Tighten terminal screws securely according to the specified torque. **Otherwise, a fire may occur.**
- Fix the Drawout type ATS firmly on a flat level using mounting screws. **Otherwise, drawout operation may cause the ATS to fall.**
- Avoid blocking of ATS's arc gas vents to ensure the adequate arc space. **Blocking of the arc gas vents could result in failure of ATS.**
- Do not place the ATS in such area of high temperature, high humidity, dusty air, corrosive gas, strong vibration and shock or other unusual conditions. **Installation in such areas could cause a fire or malfunction.**
- Be careful to prevent foreign material of debris, concrete powder, iron powder, etc and rainwater from entering into the ATS. **These materials inside the ATS could cause a fire or malfunction.**
- For 4 pole ATS, connect the neutral wire of 3-phase, 4-wire cable to N-phase (on the right side).
- 설치는 유자격자 (전기공사기사, 전기공사기능사)가 행하십시오.
- 설치에 앞서 모든 전원을 차단하기 위해 앞단의 차단기나 또는 그러한 종류의 제품을 반드시 Open 시키십시오. 감전의 위험이 있습니다.
- 단자 Bolt는 표준 체결 Torque로 확실하게 체결하십시오. 화재의 위험이 있습니다.
- 수평하고 평평한 면에 단단하게 취부하여 고정시키십시오. 인출조작시 전도의 위험이 있습니다.
- 아크가스 배출구는 막히지 않도록 아크공간(절연거리)을 충분히 확보하십시오. 개폐 성능을 저하시킵니다.
- 고온, 다습, 분진, 부식성가스, 진동, 충격 등 좋지 못한 환경에 설치하지 마십시오. 화재 및 오동작이 발생할 수 있습니다.
- 먼지, 콘크리트가루, 철분 등의 이물질 및 빗물 등이 ATS내부에 들어가지 않도록 시공하십시오. 화재 및 오동작이 발생할 수 있습니다.
- 4극형의 경우 중성 선은 반드시 N 상극(우측)에 접속하십시오.

Operation Precautions 조작시의 주의사항

⚠ Danger 위험

- Do not touch the live terminal parts.
Otherwise, electric shock may occur.
- Do not leave the ATS in the drawout position.
The ATS is heavy. Dropping the ATS could cause serious injury.
- 통전되고 있는 주회로 및 제어회로 단자부에는 접촉하지 마십시오. 감전의 위험이 있습니다.
- 인출 위치상에 ATS를 방치하지 마십시오. ATS는 중량물이어서 낙하시 비상한 위험을 초래할 수 있습니다.

⚠ Caution 주의

- The cable size of control power should be selected considering operation current.
Otherwise, a fire could occur.
- ATS should be operated by manual handle only under no-load condition. Operation by manual handle is strictly prohibited except emergency case.
Otherwise, damage to the ATS may occur.
- 조작전원의 전선의 굵기는 조작전류를 감안하여 선정하여 주십시오.
절체실때시 화재를 일으킬 수 있습니다.
- ATS 수동 핸들에 의한 조작은 무부하 상태에서 조작하며, 비상시 외에는 사용을 금합니다.
조작미숙시 개폐특성을 보증할 수 없습니다.

Maintenance and Inspection Precautions 보수, 점검과 부품 교환시의 주의사항

⚠ Caution 주의

- Maintenance, inspection or components replacement should be performed by qualified persons.
- Prior to commencing any work, open the upstream circuit breaker to isolate all power/voltage sources. **Otherwise, electric shock may occur.**
- Prior to commencing internal inspection for ATS, Be sure that main circuit and control source of ATS should be off.
Otherwise, fingers or tools could be pinched in the internal mechanism, causing injury.
- Retighten the terminal screws periodically according to the specified torque. **Otherwise, a fire may occur.**
- Retighten the arcing contact mounting screws periodically according to the specified torque. **Otherwise, a fire or malfunction may occur.**
- Be sure to reinstall the arc chute if removed.
Failure to do so or incorrect installation may result in a fire or cause of burns.
- Do not touch the live parts or structural parts close to live parts immediately after stop of power supply to ATS.
Otherwise, remaining heat may cause burns.
- Do not approach near the arc gas vent of arc chute while ATS is under transfer.
Otherwise, burns may result from high temperature of arc gas.

- 보수, 점검과 부품교환은 전문지식을 보유한 사람이 행하십시오.
- 작업은 상위차단기를 OFF 시키고 주회로, 제어회로 모두 충전되어 있지 않은 것을 확인한 뒤 행하십시오.
감전의 위험이 있습니다.
- 내부점검은 주회로 전원 및 조작전원을 차단 후 행하십시오.
손가락 및 공구가 기구부에 끼여 다칠 위험이 있습니다.
- 주회로 단자볼트는 정기적으로 표준 토크부 Torque로써 증가시켜 취부하십시오.
풀림은 화재 발생의 원인이 될 수 있습니다.
- 아크 접점 Screw를 정기적으로 표준 토크부 Torque로써 다시 취부하십시오.
화재나 오동작의 원인이 될 수 있습니다.
- 외부의 소호실은 반드시 취부하십시오.
잘못된 취부 또는 취부가 되지 않을시 화상 또는 화재의 원인이 됩니다.
- 통전정지 직후는 개폐기도전부, 특히 접점과 도전부에 근접된 구조물에 접촉하지 마십시오.
전류 열에 의해 화상의 위험이 있습니다.
- 절체중 소호실 아크가스 배출구에 신체를 근접하지 마십시오.
전류차단시 고온가스가 배출되어 화상의 위험이 있습니다.



C Company History

- Dec. 1986 Established O-Sung Industrial
- Oct. 1987 Become member of Korea Electrical Manufacturers Association
- Feb. 1990 Awarded honor of KOEMA for products development
Awarded honor of KOEMA for excellent export records
- Mar. 1990 Nominated as "Technology Intensive Enterprises" by the Office of Industrial Advancement Administration
- Jan. 1993 Authenticated of "Quality Product" for Automatic Transfer Switch by the Office of industrial Advancement Administration
- Nov. 1993 Awarded the Presidential Prize at contest for Quality Control Team
- Jun. 1995 Become member of Korea International Trade Association(KITA)
- Nov. 1995 Awarded Certificate of Quality System by Korea Standards Association Quality Assurance (KSA 9001 :1998, ISO 9002 : 1994)
- Feb. 1999 Awarded Certificate of Quality System by Korea Management Association Quality Assurance (KSA 9001 : 1998, ISO 9001 : 1994)
- Apr. 1999 ASTA certified for 2000A 50KA Air Circuit Breaker
- Feb. 2000 ASTA certified for 1600A, 3200A & 5000A 65KA Air Circuit Breaker
- May. 2000 Certified by Taiwan Power Corporation(TPC)
- Jul. 2002 CE Marked for 200A ATS
- Oct. 2005 Passed CCC(Chinese Compulsory Certification) Test in China for ACB
- Oct. 2005 Registered as Venture Enterprise

Technology that captivates world!

Quality that delights customers!



Safety Manual (안전 주의서)	2
OSS II - T, TB Type (60~400A)	6
Ordering Information (주문방법)	
Feature (특징)	
Rated Specification (정격사양)	
Outline Dimension (외형도)	
Circuit Diagram (회로도)	
SS - TN, TBN Type (60~600A)	9
Ordering Information (주문방법)	
Feature (특징)	
External View (외관명칭)	
Application and Selection (적용과 선정)	
Rated Specification (정격사양)	
Outline Dimension (외형도)	
Circuit Diagram (회로도)	
OSS - PC Type (400~6300A)	14
Ordering Information (주문방법)	
Feature (특징)	
Rated Specification (정격사양)	
Outline Dimension (외형도)	
Circuit Diagram (회로도)	
ATS Controller	24
Specification & Function (사양 및 기능)	
Wiring Diagram (결선도)	
Technical Details (기술자료)	26

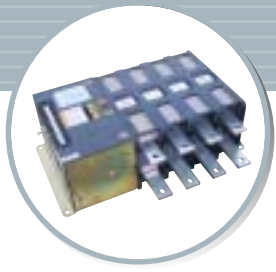

OSS II - T, TB Type

ATS(60~400A)

Ordering Information (주문방법)

OSS II - 6□-□-□P-□
A B C D

A Rated Current

06	1	2	4
60A	100A	200A	400A

B Type

- ▶ T : T-Type
- ▶ TB : TB-Type

C Number of Poles

- ▶ 2 : 2P
- ▶ 3 : 3P
- ▶ 4 : 4P

D Operating Voltage

- ▶ A1 : AC 110V
- ▶ A2 : AC 220V
- ▶ D1 : DC 110V
- ▶ D2 : DC 125V

Features (특징)

- Sure operating latch mechanism.
- High current capacity with low operating current.
- Good closing performance.
- Compact and light weight.
- Suitable for emergency power supply facilities.
- 우수한 "레지"에 의한 확실한 동작
- 최소의 조작전류로서 최대의 통전 성능
- 우수한 개폐 기능
- 소형 / 경량
- 비상 전력공급 설비에 적합

Rated Specification (정격사양)

TYPE		606-T, 606-TB 61-T, 61-TB			62-T, 62-TB			64-T, 64-TB		
Rated Operational Voltage (정격사용전압)	Ue	AC 600V, DC 125V								
Rated Current (정격전류)	Ie	60A, 100A			200A			400A		
Neutral Phase Current (중성극전류)		60A, 100A			200A			400A		
Kind of Throw (투수)		Double Throw (쌍투)								
Connection (접속방식)		Front (T), Back (TB) (표면, 배면)								
Number of poles (극수)		2P	3P	4P	2P	3P	4P	2P	3P	4P
Weight (중량)		14kg	16kg	18kg	16kg	19kg	22kg	16kg	19kg	22kg
Rated Short-Time Withstand Current (1sec) (정격 단시간 전류)	Icw	5kA			10kA			12kA		
Short-Circuit Making Capacity (단락 피크 전류)	Icm	7.65kA			17kA			24kA		
Switching Capacity (개폐 용량)		AC - 33B (6Ie making / 6Ie breaking cos φ= 0.5) DC - 31B (1.5Ie making / 1.5Ie breaking L/R = 1ms)								
Switching Frequency (개폐빈도)		60Time / Hour								
Operating Current (조작전류) rms/pick	DC 110V / 125V	14A			14A			14A		
	AC 100V / 110V	7A / 14A			7A / 14A			7A / 14A		
	AC 200V / 240V	3.5A / 7A			3.5A / 7A			3.5A / 7A		
Operating Time (동작시간)	Change - over time	≤ 80 ms								
	Opening time	≤ 60 ms								
Number of Operating Cycles (정격개폐회수)	Without Current (무통전)	10,000								
	With Current (통전)	5,000								
Cautions (주의사항)		1. For complete operation, Be sure to provide control source for more than 0.5sec. 2. When control source will be provided to A side and B side simultaneously, Coil may be damaged. 3. Control Relay should be selected considering sufficient contact capacity to withstand against more than control current. 1. 조작지령은 0.5sec이상으로 하여 확실한 동작을 할 수 있도록 하여 주십시오. 2. A측, B측 동시 조작지령시 코일 소손의 원인이 됩니다. 3. 조작 Relay는 조작전류 이상의 충분한 접점용량을 선정하여 주십시오.								

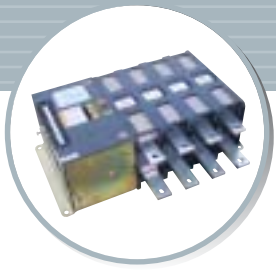

OSS II - T, TB Type

ATS(60~400A)

Outline Dimension (외형도)

OSS II - T Type

① Operating circuit terminal
조작전원 단자대

② Manual handle inlet
수동핸들 삽입구

③ A Power source side main circuit terminal
A 전원측 주회로 단자

④ Load side main circuit terminal
부하측 주회로 단자

⑤ B Power source side main circuit terminal
B 전원측 주회로 단자

⑥ Change over indicator
절체 표시기

OSS II - TB Type

R S T N

PANEL CUT

unit : mm

MODEL	CURRENT	POLE	A	B	C	D	F	G	I	T
606~61-T	60A	2 P	280	260	170	50	20	ø 8	87	4
		3 P	330	310						
606~61-TB	100A	4 P	380	360	175	60	30	ø 10	86	6
		2 P	300	280						
62-T	200A	3 P	360	340	175	60	30	ø 10	86	6
		4 P	420	400						
64-T	400A	2 P	300	280	175	60	30	ø 10	86	6
		3 P	360	340						
64-TB	400A	4 P	420	400	175	60	30	ø 10	86	6
		2 P	300	280						

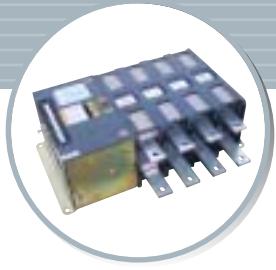

OSS II - T, TB Type

ATS(60~400A)

Circuit Diagram (회로도)

AC 110V, AC 220V

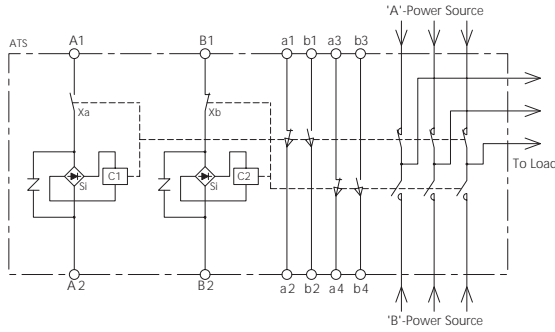

DC 110V, DC 125V

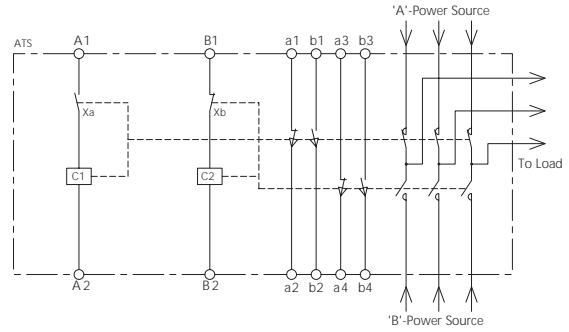

A1 , A2	A-Power Closing Terminal	Xa , Xb	Control Switch
B1 , B2	B-Power Closing Terminal	a1, a2, a3, a4	A-Power Aux Switch
C1	A-Power Closing Coil	b1, b2, b3, b4	B-Power Aux Switch
C2	B-Power Closing Coil	Si	Silicon Rectifier

Typical Operating Circuit (대표적 조작회로 예)

Standard
(일반적인 절체)

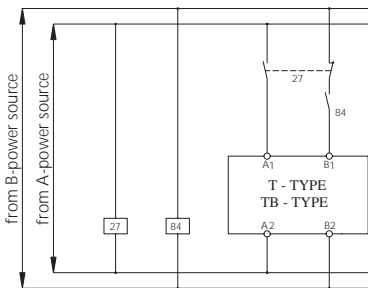

In case of using a changeover switch
(수동-자동 절체)

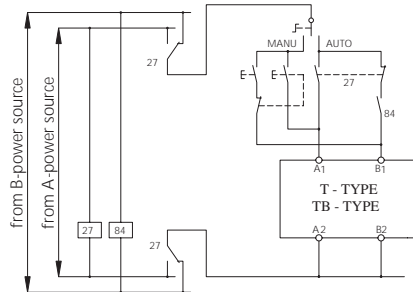

In case of using a timer
(타이머를 이용한 절체)

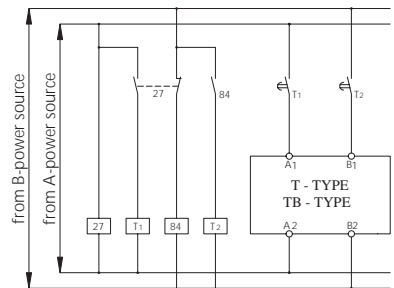

Wiring Diagram (결선도)

AC Operating and Control

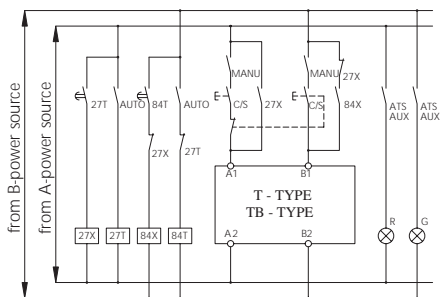

DC Operating and Control

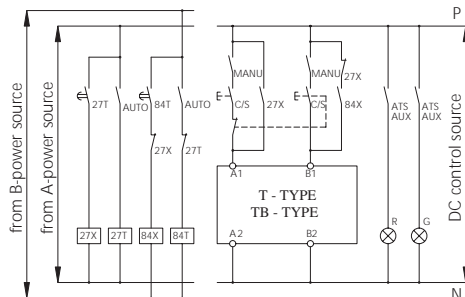

27X	Source-A Operating Relay	84X	Source-B Operating Relay
27T	27X Operating Delay Relay	84T	84X Operating Delay Relay
AUTO, MAN	Automatic , Manual	C/S	Control Switch



Ordering Information (주문방법)

OSS - 6□-□-□P-□
A B C D

A Rated Current

06	1	2	4	6
60A	100A	200A	400A	600A

B Type

- ▶ TN : TN-Type
- ▶ TBN : TBN-Type

C Number of Poles

- ▶ 2 : 2P
- ▶ 3 : 3P
- ▶ 4 : 4P

D Operating Voltage

- ▶ A1 : AC 110V
- ▶ A2 : AC 220V
- ▶ D1 : DC 110V
- ▶ D2 : DC 125V

Features (특징)

■ Neutral Point Method

When transfer is accompanied by uninterrupted power to the load, it is recommended to transfer after checking circuit stability rather than instant transferring in case of power failure or restoration. In order to meet these requirements, positioning at neutral point(off-position) can be set by tripping mechanism as follows.

A⇒Off⇒B, B⇒Off⇒A, and A⇒Off⇒A, B⇒Off⇒B

And also, instantaneous transfer can be performed by operating signal.

■ One-Coil Application

One-coil is employed for the transfer of normal power source and emergency power source.

■ Compact & Lightweight Design

Compact & lightweight design makes the minimized mounting space and easier installation.

■ Excellent Breaking Capacity

It is designed for large arc-extinguishing chamber sufficient enough to interrupt large amount of arcing current. Arc-extinguishing contacts are designed for easier inspection and maintenance.

■ Protection against Residual Voltage

Setting for delayed transfer time is available by external sequence. Thus, collision between power source and residual voltage of load can be protected.

■ Construction for Safety

For safe operation, molded construction is employed on breaking parts. And also, latching indicator is prepared to indicate the latching condition.

■ 중간정지 방식

무정전 전원장치가 있는 경우 정전 또는 복전시 긴급 절체 되는것 보다는 회로의 안정 및 안전을 확인한 후 절체할 수 있는 방식으로 트립장치에 의해 중간차(off)가 가능합니다.

A⇒Off⇒B, B⇒Off⇒A, and A⇒Off⇒A, B⇒Off⇒B

또한 조작 지령에 의해 종전품과 동일하게 긴급절체도 가능합니다.

A⇒B, B⇒A

■ 단일코일 방식

한개의 코일로 절체하는 방식입니다.

■ 소형 경량

작고 가벼워 공간 활용 및 작업자 능률이 높아집니다.

■ 강력한 차단 능력

독특한 구조의 소호실 설계로 아크차단이 짧고 접점의 소모가 적아 장기간 사용 가능하며 전면에서 소호실을 열수있어 내부 접점의 점검이 편리합니다.

■ 부하측 잔류전원 혼촉 방지

Neutral(OFF)부의 TN형은 외부시퀀스에 의해 절체시간을 임의설정하여 전원과 부하측 잔류 전압과의 혼촉을 확실하게 방지할 수 있습니다.

■ 안전 구조 설계

차단부가 분진방지형 몰드구조로 설계되었고, 동작 위치 표시기가 있어 수명이 길고 사용자가 안전합니다.

External View (외관명칭)

- 1 Earthing Terminal (접지단자)
- 2 Manual Operating Shaft (Anti-Clockwise) (수동조작 바)
- 3 Circuit Diagram (회로도)
- 4 Name Plate (명판)
- 5 Trip Button (트립 버튼)
- 6 Selective Button for "B" Power-Closing (선택 버튼)
- 7 On/Off Indicator (동작표시기)
- 8 Circuit Terminal for "A" Power (A전원측 주회로 단자)
- 9 Contacts (접점부)
- 10 Arc-Extinguishing Chamber (소호실)
- 11 Aux Switch (보조스위치)
- 12 Circuit Terminal for "B" Power (B전원측 주회로 단자)
- 13 Control Circuit Terminal Block (조작전원 단자대)
- 14 Main Circuit Terminal for Load (부하측 주회로 단자)
- 15 Amateur for Closing Coil (투입 코일)

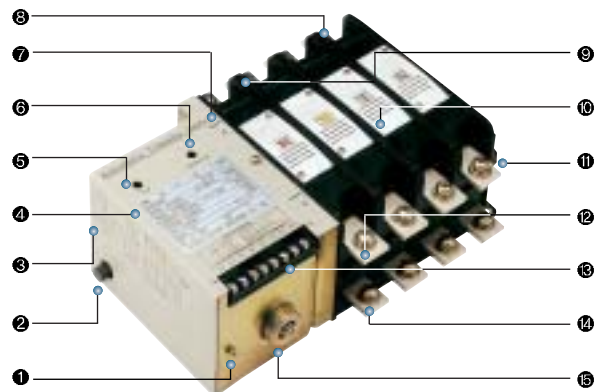

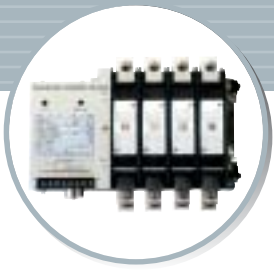

Application and Selection (적용과 선정)

- Applicable Standards**
 - IEC 60947-6-1 · JEM 1038 · UL 1008
 - KSC 4504 · KSC 0703
- Control Order**

Input and trip delayed operation is completed within 0.3 sec, However, sequence setting is required to control with more than 0.5 sec.
- Interlock**

Interlocking is required for control circuit so that control order should not supply to both A power source side and B power source side simultaneously. For TN type ATS, Sequence setting is required so that closing or tripping order should not supply in the same direction.
- Control Circuit**

ATS is designed so that operation current should be off by internal switch after completion of operation. If operation current is off with auxiliary switch of the unit, it may cause a malfunction.
- 관련규격**
 - IEC 60947-6-1 · JEM 1038 · UL 1008
 - KSC 4504 · KSC 0703
- 제어지령**

투입 및 트립 지연동작은 0.3초이내에 완료되지만 0.5초 이상의 제어지령으로 동작될 수 있도록 Sequence를 설정하여 주십시오.
- 인터록**

조작회로에는 A전원측과 B전원측에 동시지령이 되지 않도록 인터록(전기적)을 설치하여 주십시오. TN형의 경우 동일방향으로 투입, 트립 지령이 되지 않도록 Sequence를 설정 하여 주십시오.
- 제어회로**

ATS는 동작완료 후 내부 SW에 의해 조작전류를 OFF하도록 설계되어 있습니다. 본체의 보조 SW로 조작전류를 OFF하면 오동작의 원인이 됩니다.

Rated Specification(정격사양)

TYPE		606-TN, TBN 61-TN, TBN			62-TN, TBN			64-TN, TBN 66-TN, TBN			
Rated Operational Voltage (정격사용전압)	Ue	AC 600V, DC 125V									
Rated Current (정격전류)	Ie	60A, 100A			200A			400A, 600A			
Neutral Phase Current (중성극전류)		60A, 100A			200A			400A, 600A			
Kind of Throw (투수)		Double Throw (쌍투)									
Connection (접속방식)		Front(TN), Back(TBN) (표면, 배면)									
Number of poles (극수)		2P	3P	4P	2P	3P	4P	2P	3P	4P	
Weight (중량)		14kg	16kg	18kg	16kg	19kg	22kg	16kg	19kg	22kg	
Rated Short-Time Withstand Current (1sec) (정격 단시간 전류)	Icw	5kA			10kA			12kA			
Short-Circuit Making Capacity (단락 피크 전류)	Icm	7.65kA			17kA			24kA			
Switching Capacity (개폐 용량)		AC - 33B (6Ie making / 6Ie breaking cos φ= 0.5) DC - 31B (1.5Ie making / 1.5Ie breaking L/R = 1ms)									
Switching Frequency (개폐빈도)		60Time / Hour									
Operating Current (조작전류) rms/pick	DC 110V / 125V	6A			6A			7A			
	AC 100V / 110V	3A/6A			3A/6A			3.5A/7A			
	AC 200V / 240V	1.5A/3A			1.5A/3A			2A/3.5A			
	Trip Coil Current	DC 110V = 2.5A, AC 110A = 2.5A, AC 220V = 1.5A									
Operating Time (동작시간)	"A" POWER	Making	≤ 55 ms			≤ 55 ms			≤ 60 ms		
		Breaking	≤ 20 ms			≤ 20 ms			≤ 25 ms		
	"B" POWER	Making	≤ 80 ms			≤ 80 ms			≤ 90 ms		
		Breaking	≤ 20 ms			≤ 20 ms			≤ 25 ms		
Number of Operating Cycles (정격개폐수명)	Without Current (무통전)		10,000								
	With Current (통전)		5,000								
Cautions (주의사항)	1. For complete operation, Be sure to provide control source for more than 0.5sec. 2. When control source will be provided to A side and B side simultaneously, Coil may be damaged. 3. Control Relay should be selected considering sufficient contact capacity to withstand against more than control current. 1. 조작지령은 0.5sec이상으로 하여 확실한 동작을 할 수 있도록 하여 주십시오. 2. A측, B측 동시 조작지령시 코일 소손의 원인이 됩니다. 3. 조작 Relay는 조작전류 이상의 충분한 접점용량을 선정하여 주십시오.										

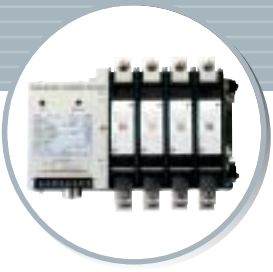

Outline Dimension (외형도)

60A, 100A

606-TN, 61-TN

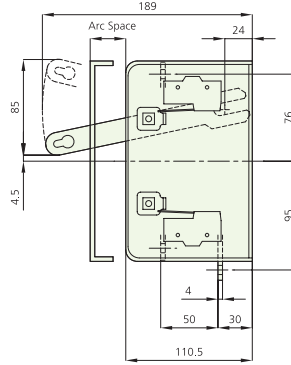
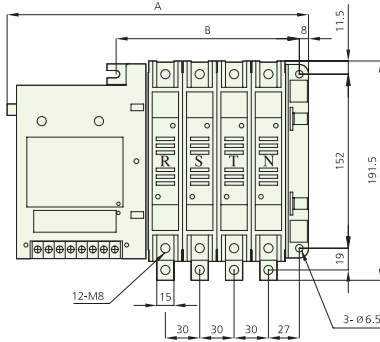

Dimension (mm)		
Pole	A	B
2 P	204	100
3 P	234	130
4 P	264	160

200A

62-TN

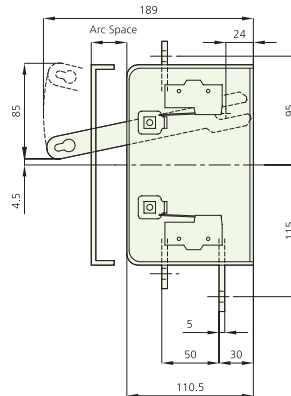
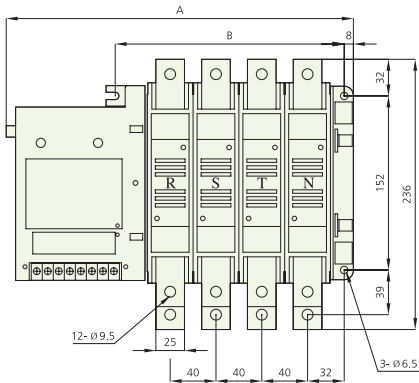

Dimension (mm)		
Pole	A	B
2 P	224	120
3 P	264	160
4 P	304	200

400A, 600A

64-TN, 66-TN

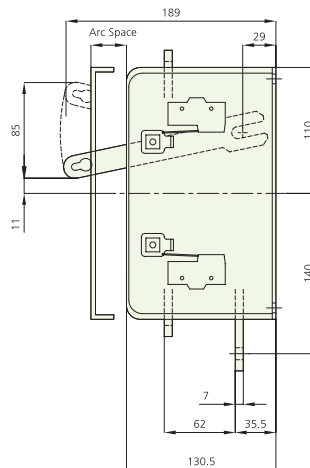
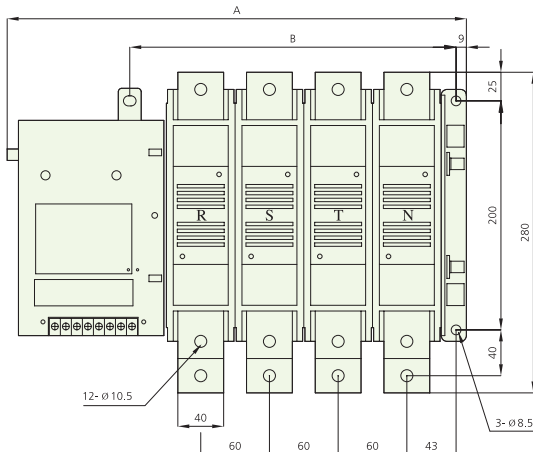

* Arc space for main circuit
 - 30mm for AC 220V
 - 60mm for AC 660V

Dimension (mm)		
Pole	A	B
2 P	283	165
3 P	343	225
4 P	403	285

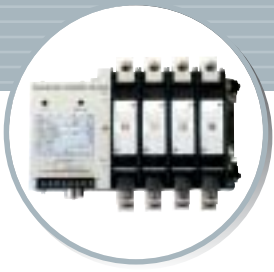

Outline Dimension (외형도)

606-TBN~66-TBN

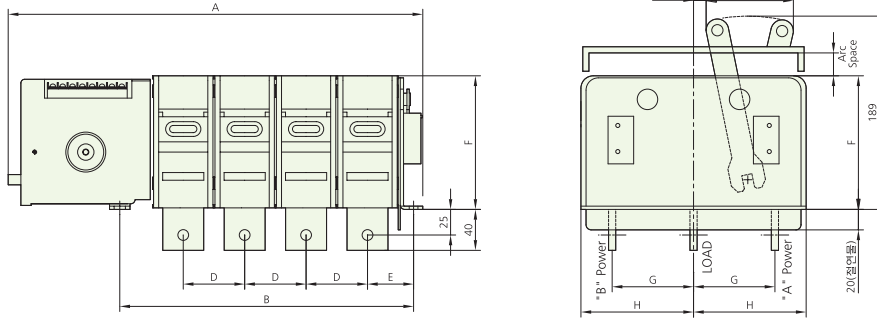

* Arc space for main circuit
 - 30mm for AC 220V
 - 60mm for AC 600V

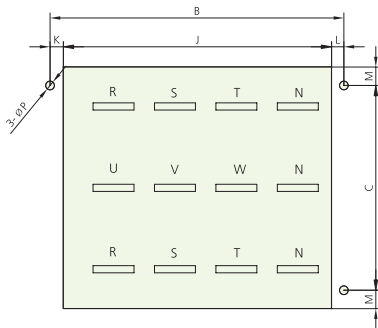

PANEL CUTTING

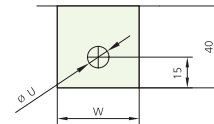

TERMINAL THICKNESS

	606-TBN 61-TBN	62-TBN	64-TBN	66-TBN
W	15	25	40	
U	ø 8.5		ø 10.5	
t	4	5	7	

unit : mm

		A	B	C	D	E	F	G	H	J	K	L	M	P
606-TBN 61-TBN	2 P	206	102	152	30	29	110.5	62.5	87.5	82	9	11	19	ø 6.5
	3 P	236	132							112				
	4 P	266	162							142				
62-TBN	2 P	226	122	152	40	34	110.5	63	87.5	102	9	11	19	ø 6.5
	3 P	266	162							142				
	4 P	306	202							182				
64-TBN 66-TBN	2 P	285	167	200	60	45	130.5	79.5	110	142	13	12	18	ø 8.5
	3 P	345	227							202				
	4 P	405	287							262				

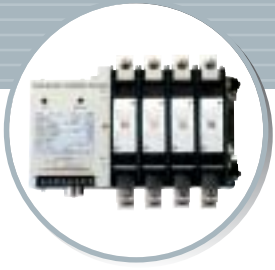

Circuit Diagram (회로도)

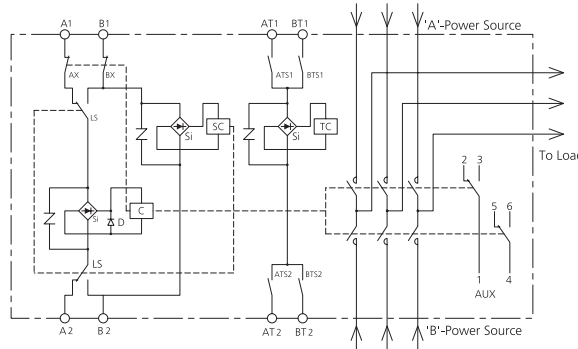

A1, A2	A-Power Closing Terminal	C	Closing Coil
B1, B2	B-Power Closing Terminal	SC	Selective Coil
AT1, AT2	A-Power Tripping Terminal	TC	Tripping Coil
BT1, BT2	B-Power Tripping Terminal	AX, BX	Control Switch
AUX	Aux Switch	ATS1, ATS2 BTS1, BTS2	Trip Control Switch
Si	Silicon Rectifier	LS	Selective Switch

Typical Operating Circuit (대표적 조작회로 예)

Standard
(일반적인 절체)

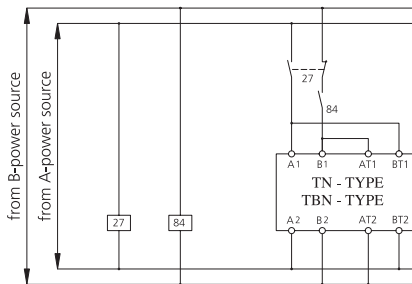

In case of using a changeover switch
(수동-자동 절체)

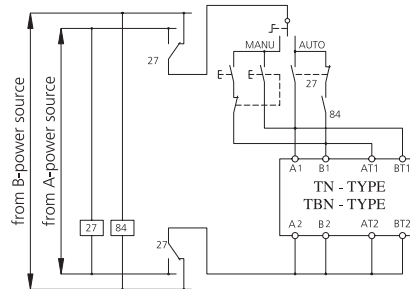

In case of using a timer
(타이머를 이용한 절체)

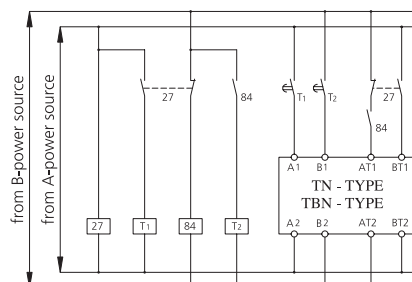

In case of using a condenser tripping device
(콘덴서 트립)

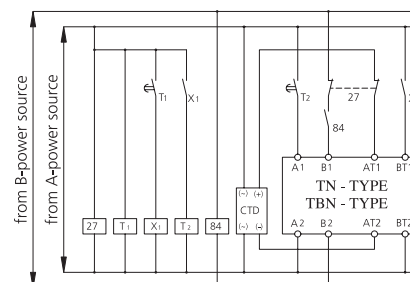



OSS - PC Type

ATS(400~6,300A)

Ordering Information (주문방법)

OSS - 6□-□-□P-□-□
A B C D E

A Rated Current

04	06	08	10	12	16	20	25	32	40	50	63
400A	630A	800A	1000A	1250A	1600A	2000A	2500A	3200A	4000A	5000A	6300A

B Type

- ▶ PC : Standard
- ▶ PCO : Overlapping contacts

C Number of Poles

- ▶ 3 : 3P
- ▶ 4 : 4P

D Operating Voltage

- ▶ A1 : AC 110V
- ▶ A2 : AC 220V
- ▶ D1 : DC 110V
- ▶ D2 : DC 125V

E Mounting System

- ▶ F : Fixed
- ▶ D : Draw out

Features (특징)

- **One coil mechanism**
One coil mechanism is applied.
- **Transfer indicator provided**
Transfer indicator is fitted to indicate the transfer status.
- **Easier busbar arrangement**
When ATS will be installed with ACB in switchgear, Busbars can be easily arranged.
- **Fixed type & Drawout type available**
Fixed type and Drawout type are available for customer's convenient application.
- **Quick replacement of ATS**
When fault will occur, Drawout type ATS can be replaced within 5 minutes.
- **Complete transfer ensured**
By spring transfer mechanism, incomplete transfer of conventional ATS can be entirely eliminated and complete transfer can be ensured.
- **Sufficient current capacity**
Sufficient current carrying contacts are designed to withstand against over current.
- **Minimized opening & Closing impact**
Opening and closing impact is minimized.
- **Overlapping function for N-phase** Option
This function is added as option on Neutral Contacts of PC-type ATS and enables followings.
 - Overlapping of Neutral Contacts both to A side and B side.
 - Opening of Neutral Contacts later than other 3-phase Contacts.
- **1코일 절체 기구**
정평이 있는 1코일 절체기구를 채택 했습니다.
- **절체표시기 부착**
절체의 상태를 확인할 수 있는 절체표시기를 부착하였습니다.
- **부스바작업간편**
ACB와 함께 배전반 설치시 부스바작업이 간편합니다.
- **다양한 고객욕구를 만족**
고정형과 인출형이 있어 다양한 고객욕구를 만족 시킬 수 있습니다.
- **ATS교체 시간 단축**
인출형이 있어 사고발생시 ATS교체 시간이 5분 이내 입니다.
- **불완전 투입요소 완전 제거**
SPRING 절체타입으로 기존의 ATS의 문제점인 불완전 투입요소를 완전하게 제거 하였습니다.
- **과전류 방지**
통전부의 독특한 접점구조에 의해서 과전류에 충분히 이겨 낼 수 있도록 설계되어 있습니다.
- **개폐쇼크 미미**
개폐조작시 개폐쇼크가 극소합니다.
- **중성선(N상) 중첩절환기능** Option
ATS의 중성접점(Neutral Contact)에 기능을 추가하여 ATS절환 시 중성접점이 A측과 B측에 중첩되어 불고 다른 3접점(상상)에 비하여 나중에 떨어지는 방식을 중첩절환기능이라 합니다.



Necessity of overlapping function for N-phase (N상 중첩절환기능의 필요성)

■ Neutral Contacts of general ATS are closed earlier and are opened later than 3-phase Contacts. When general ATS will be transferred, Arc will be generated between fixed contacts and moving contacts. Thus, current flows between contacts. Arc will be eliminated when current will be at zero level. Eliminating time of arc is 10-12 msec. Therefore, various devices of load side can be protected while Neutral Contacts should be opened 10-12 msec later than other 3-phase Contacts.

Load side devices of general ATS cannot be sufficiently protected because opening time gap between Neutral Contacts and other 3-phase Contacts is less than 10 msec.

In order to solve this problem, Overlapping is functioned between Neutral Contacts of A-power (Utility) and B-power (Emergency) during transfer of ATS. Thus, various devices of load side can be protected more safely.

In addition, Non-linear load increases the earth potential and potential difference is occurred between earth and neutral line. When general ATS will be transferred, Neutral line is separated from load and reference potential difference cannot be established. Thus, Floating is occurred and electronic devices can be malfunctioned. When ATS with overlapping function will be applied, Floating can be protected.

- Location needed for overlapping function
 - Broadcasting system and telecommunication system
 - Bank and computer center
 - Petrochemical plant
 - Military communication system and radar facilities
 - Arc furnace
 - Large harmonic load (Elevator & Escalator, etc)

■ 일반적인 ATS의 경우 중성접점(N상)이 다른 3점점(상상)보다 먼저 붙고 나중에 떨어지는 것을 기본으로 하고 있습니다. 일반적인 ATS는 절체 시 고정자와 가동자의 접점사이에서 ARC가 발생하여 접촉자간에 전류를 지속 시키게 되며, ARC는 전류의 영점에서 사라져 없어지게 됩니다. 이때, ARC의 소멸시간은 대략 10~12msec 정도가 됩니다. 그러므로 중성접점(N상)은 다른 3점점(상상)보다 10~12msec후에 떨어져야 부하측의 각종 장비가 보호됩니다. 그러나 일반적인 ATS는 중성접점(N상)과 다른 3점점(상상)의 시간차가 10msec 이내가 되므로 부하측의 설비를 보호하는데 다소 미흡하다 할 수 있습니다. 이러한 문제를 해결하기 위하여 상용전원의 중성점점과 비상전원의 중성점점을 중첩시켜 절체 시킴으로써 보다 안전하게 부하측의 각종 장비를 보호할 수 있습니다.

또한, 비선형부하는 대지전위를 상승시켜 대지와 중성선간에 전위차가 생기므로 일반적인 ATS는 절체 시 중성선이 부하측과 분리되어 기준전위가 확립되지 않아 플로팅현상이 발생되어 전자장비가 오동작을 유발합니다. 그러므로 중첩절환 기능이 내장된 ATS를 사용함으로써 플로팅현상을 예방할 수 있습니다.

- 중첩절환기능을 필요로 하는 장소로는 다음과 같습니다.
 - 방송국 및 통신전화국
 - 은행 및 전산시설
 - 석유 화학 플랜트
 - 군 통신 및 레이더 시설
 - 각종 전기로
 - 다량의 고조파 발생 부하 (엘리베이터, 에스컬레이터 등)

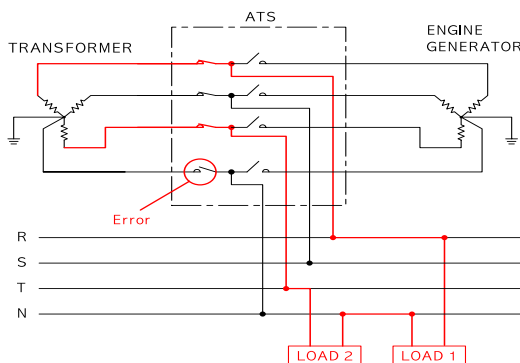

General ATS

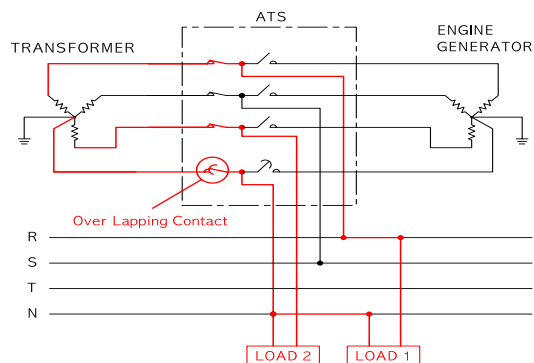

Overlapping function ATS



OSS - PC Type

ATS(400~6,300A)

Rated Specification (정격사양)

TYPE		604-PC 606-PC		608-PC 610-PC		612-PC		616-PC		620-PC			
Rated Voltage (정격 전압)	Ue	AC 600V, DC 125V											
Rated Current (정격 전류)	Ie	400A, 630A		800A, 1000A		1250A		1600A		2000A			
Neutral Phase Current (중성극전류)		400A, 630A		800A, 1000A		1250A		1600A		2000A			
Kind of Throw (투수)		Double Throw (쌍투)											
Connection (접속 방식)		Back (배면)											
Number of Poles (극수)		3P	4P	3P	4P	3P	4P	3P	4P	3P	4P		
Weight (중량)	Fixed (고정)	50kg	60kg	55kg	65kg	60kg	70kg	65kg	75kg	75kg	90kg		
	Drawout (인출)	75kg	90kg	80kg	95kg	90kg	105kg	95kg	110kg	110kg	140kg		
Rated Short-Time Withstand Current (1sec) (정격 단시간 전류)	Icw	20kA		25kA		30kA		35kA		40kA			
Short-Circuit Making Capacity (단락 Pick 전류)	Icm	40kA		52.5kA		63kA		73.5kA		84kA			
Switching Capacity (개폐 용량)		AC-33B (6 Ie making / 6 Ie breaking cos φ= 0.5) DC-31B (1.5 Ie making / 1.5 Ie breaking L/R=1ms)											
Switching Frequency (개폐 빈도)		60Time / Hour				20Time / Hour				10Time / Hour			
Operating Current (조작전류) rms/pick	DC 110V / 125V	45A				50A				65A			
	AC 100V / 110V	23A/45A				25A/50A				33A/65A			
	AC 200V / 240V	15A/30A				20A/40A				25A/50A			
Operating Time (동작시간)	Change - over time	≤ 120 ms											
	Opening time	≤ 90 ms											
Number of Operating Cycles (정격 개폐 회수)	Without Current	10,000								5,000			
	With Current	5,000								3,000			
Cautions (주의사항)		1. For complete operation, Be sure to provide control source for more than 0.5sec. 2. When control source will be provided to A side and B side simultaneously, Coil may be damaged. 1. 조작지령은 0.5sec이상으로 하여 확실한 동작을 할 수 있도록 하여 주십시오. 2. A측, B측 동시 조작 지령시 코일 소손의 원인이 됩니다.											

TYPE		625-PC		632-PC		640-PC		650-PC		663-PC			
Rated Voltage (정격 전압)	Ue	AC 600V, DC 125V											
Rated Current (정격 전류)	Ie	2500A		3200A		4000A		5000A		6300A			
Neutral Phase Current (중성극전류)		2500A		3200A		4000A		5000A		6300A			
Kind of Throw (투수)		Double Throw (쌍투)											
Connection (접속 방식)		Back (배면)											
Number of Poles (극수)		3P	4P	3P	4P	3P	4P	3P	4P	3P	4P		
Weight (중량)	Fixed (고정)	75kg	90kg	80kg	100kg	145kg	180kg	160kg	200kg	160kg	200kg		
	Drawout (인출)	110kg	140kg	125kg	155kg	220kg	275kg	245kg	305kg	245kg	305kg		
Rated Short-Time Withstand Current (1sec) (정격 단시간 전류)	Icw	50kA		50kA		65kA		65kA		65kA			
Short-Circuit Making Capacity (단락 Pick 전류)	Icm	105kA		105kA		143kA		143kA		143kA			
Switching Capacity (개폐 용량)		AC-33B (6 Ie making / 6 Ie breaking cos φ= 0.5) DC-31B (1.5 Ie making / 1.5 Ie breaking L/R=1ms)											
Switching Frequency (개폐 빈도)		10Time / Hour											
Operating Current (조작전류) rms/pick	DC 110V / 125V	65A				80A							
	AC 100V / 110V	33A/65A				40A/80A							
	AC 200V / 240V	25A/50A				33A/65A							
Operating Time (동작시간)	Change - over time	≤ 120 ms											
	Opening time	≤ 90 ms											
Number of Operating Cycles (정격 개폐 회수)	Without Current	5,000				3,000							
	With Current	3,000				1,500							
Cautions (주의사항)		1. For complete operation, Be sure to provide control source for more than 0.5sec. 2. When control source will be provided to A side and B side simultaneously, Coil may be damaged. 1. 조작지령은 0.5sec이상으로 하여 확실한 동작을 할 수 있도록 하여 주십시오. 2. A측, B측 동시 조작 지령시 코일 소손의 원인이 됩니다.											

OSS - PC Type

ATS(400~6,300A)



Outline Dimension (외형도)

400~1600A Fixed

unit : mm

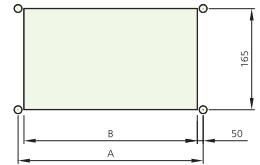
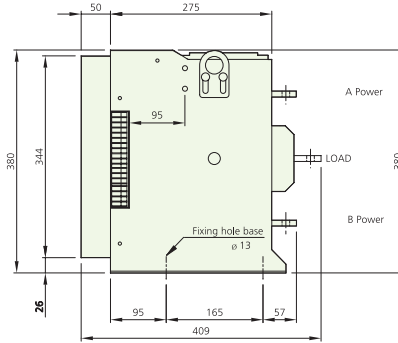
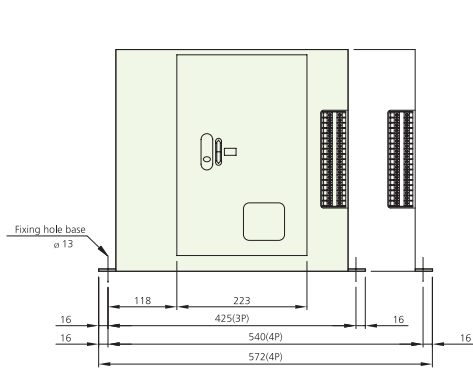

Poles	A	B
3P	425	325
4P	540	440

Panel cutting
(Fixing hole)

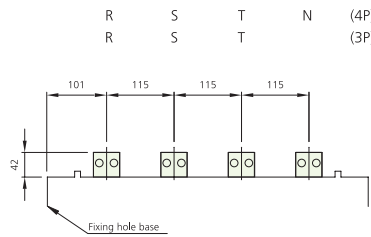
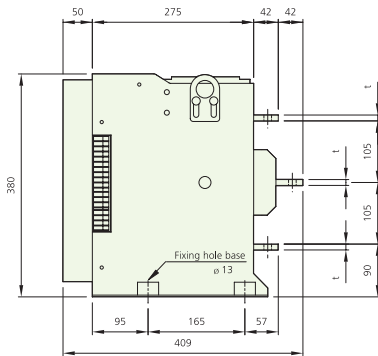

OSS-604~610-PC

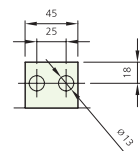

Current	Thickness
400~630A	6
800~1000A	10

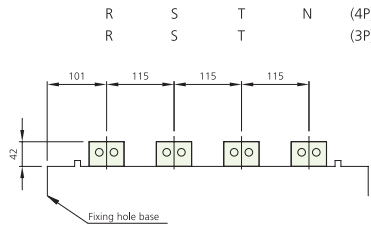
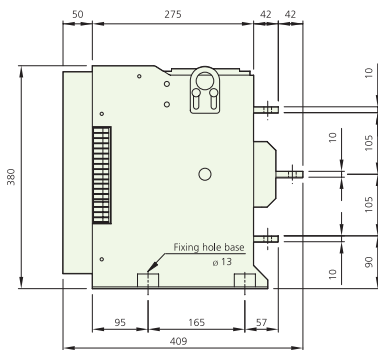

OSS-612-PC

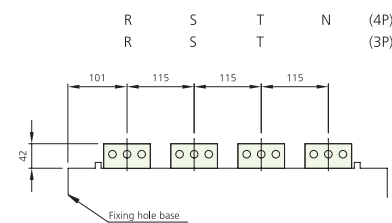
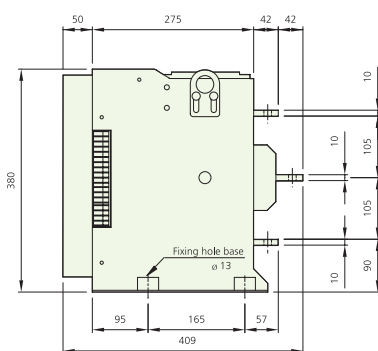
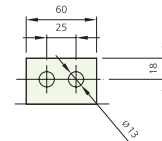

OSS-616-PC

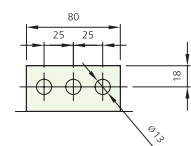

OSS - PC Type

ATS(400~6,300A)



Outline Dimension (외형도)

2000~3200A Fixed

unit : mm

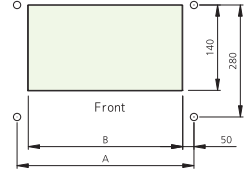
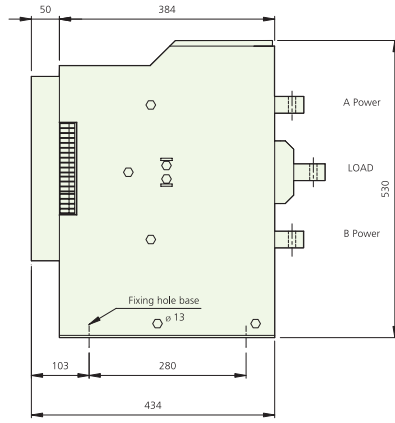
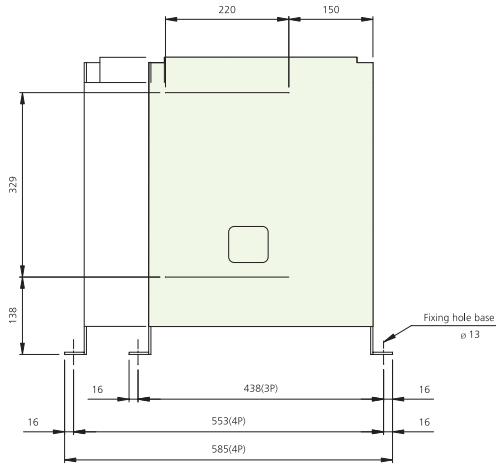

Poles	A	B
3P	438	338
4P	553	453

Panel cutting
(Fixing hole)

OSS-620~625-PC

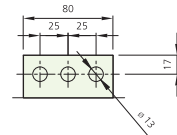
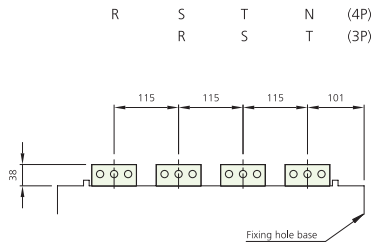
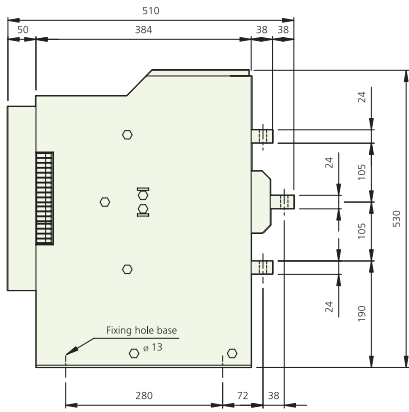

OSS-632-PC

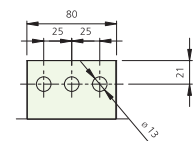
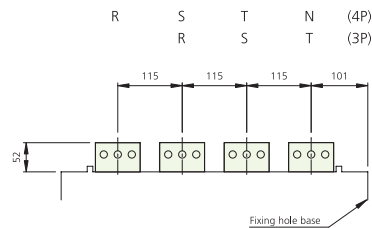
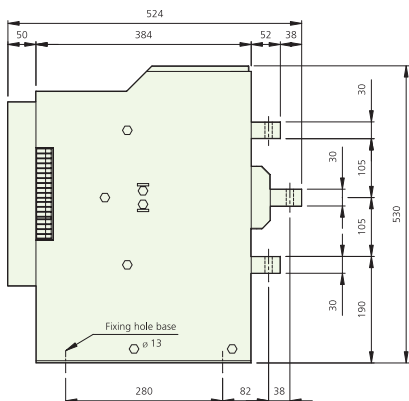

OSS - PC Type

ATS(400~6,300A)



Outline Dimension (외형도)

4000~6300A Fixed

unit : mm

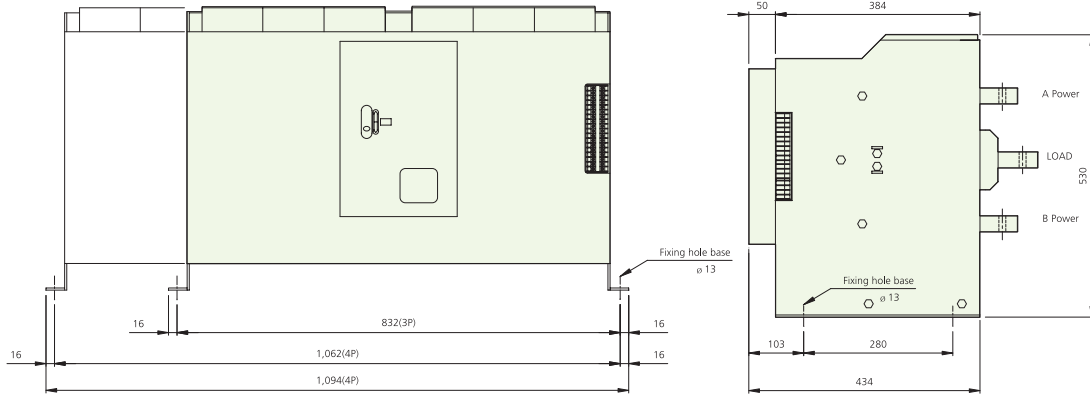

OSS-640-PC

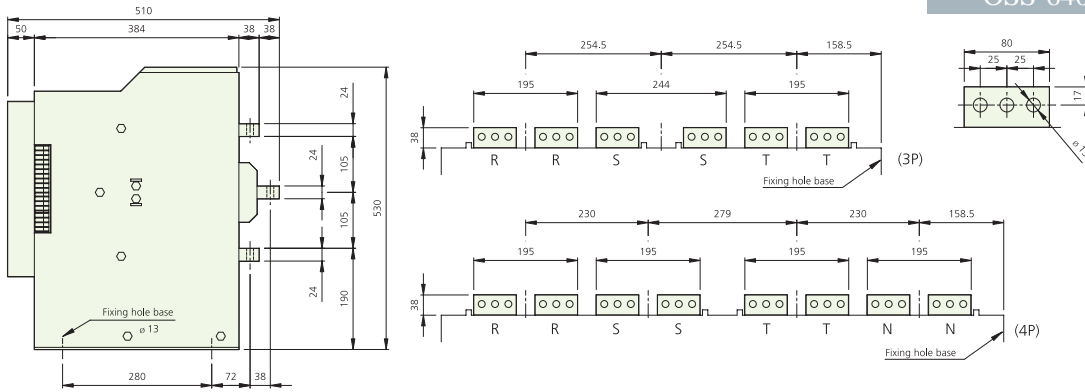

OSS-650~663-PC

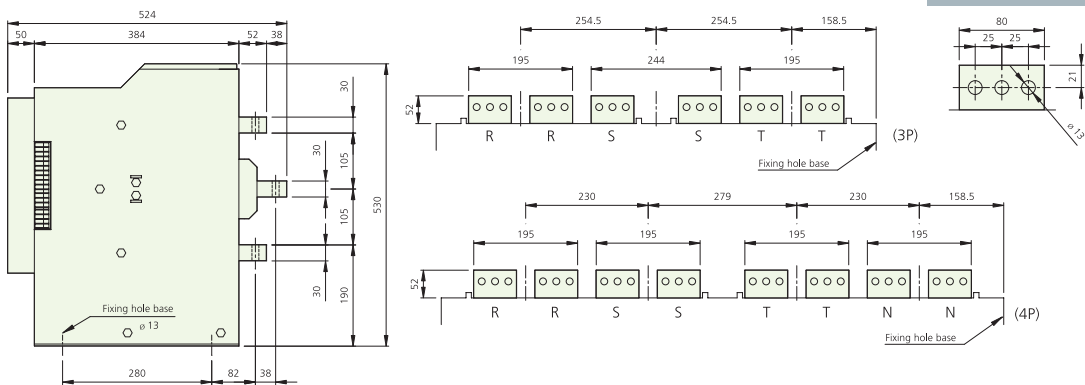

Panel cutting (Fixing hole)

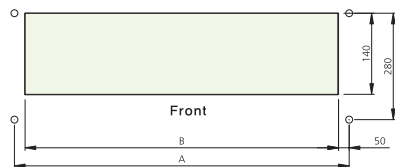

Poles	A	B
3P	832	732
4P	1062	962



Outline Dimension (외형도)

400~1600A Draw Out

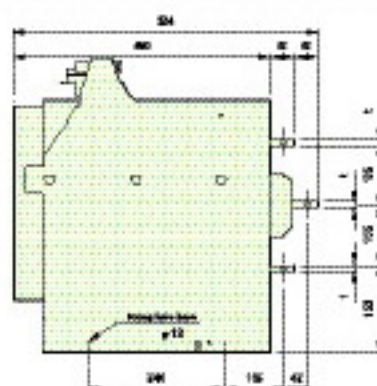
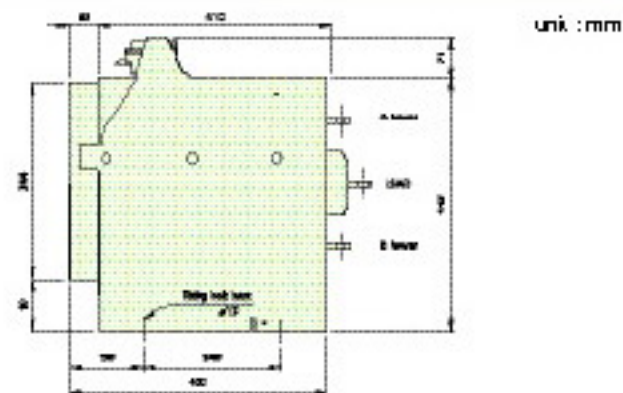
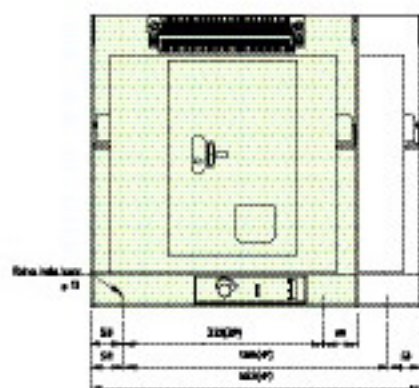

OSS-604~610-PC

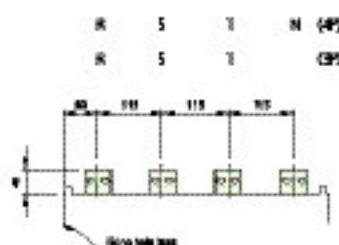

Current	Thickness
400-630A	6
800-1000A	10



OSS-611-PC

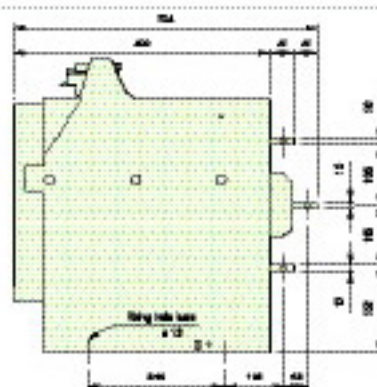
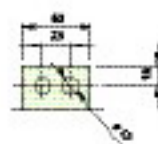
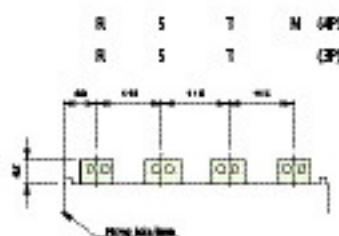

OSS-616-PC

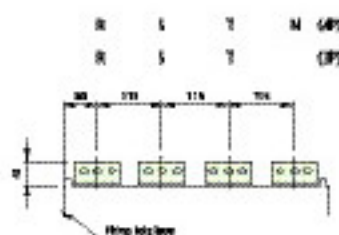



OSS - PC Type

ATS(400~6,300A)

Outline Dimension (외형도)

2000~3200A Draw Out

unit : mm

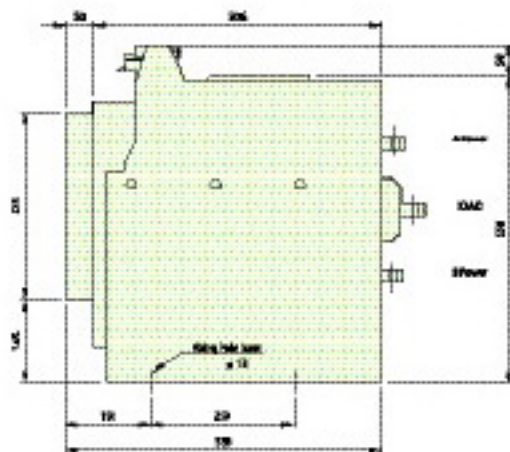
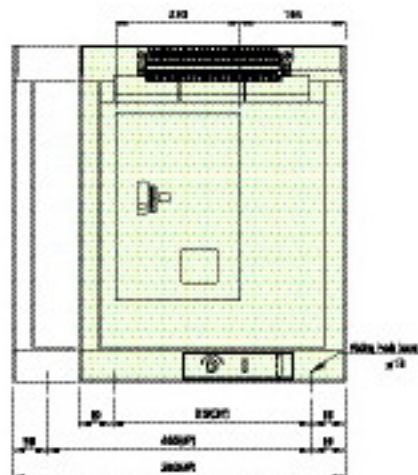

OSS-620~625-PC

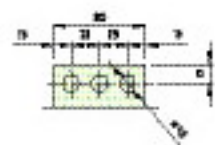
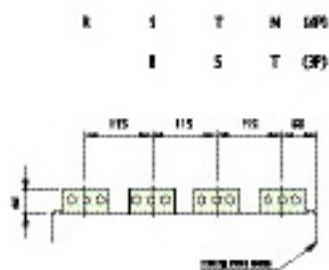
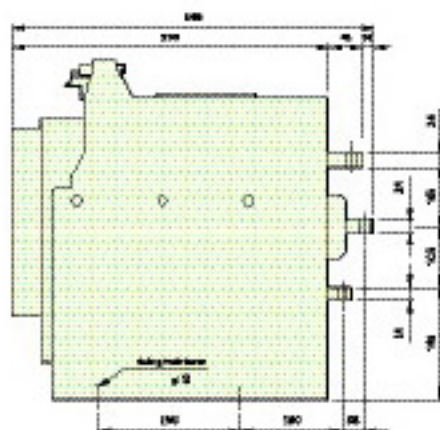

OSS-632-PC

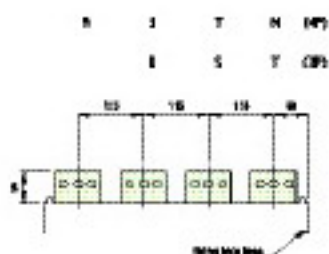
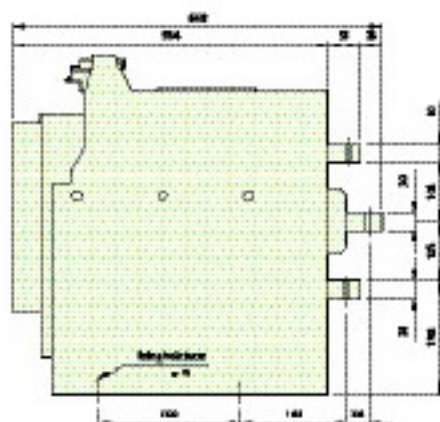



Outline Dimension (외형도)

4000~6300A Draw Out

unit : mm

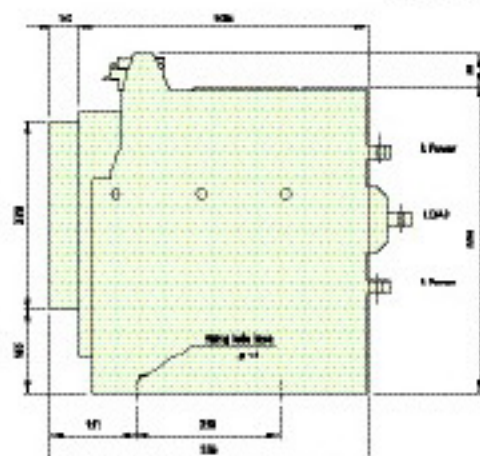
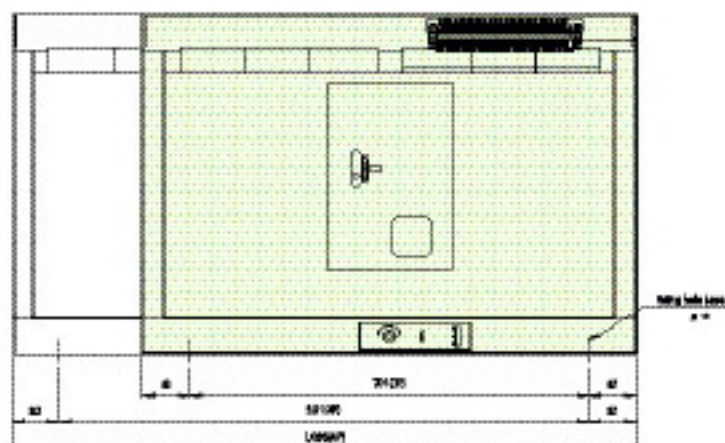

OSS-640-PC

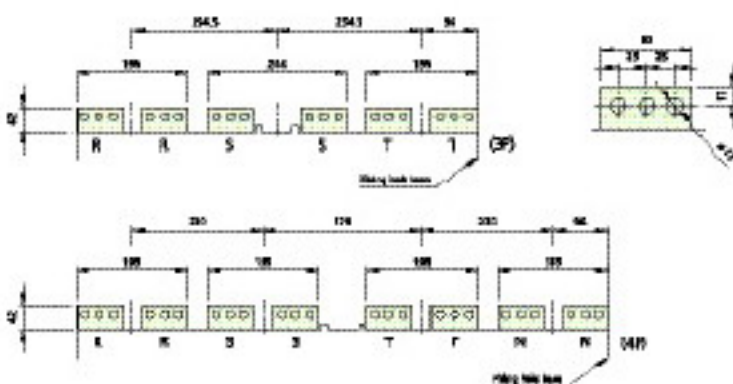
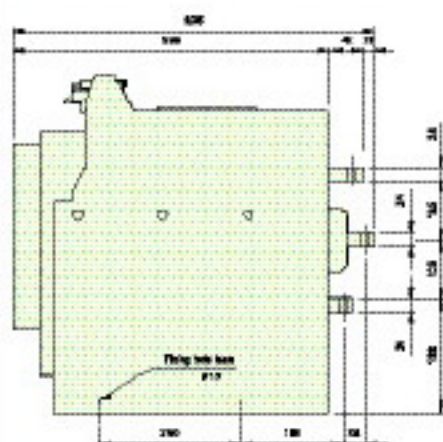

OSS-650~663-PC

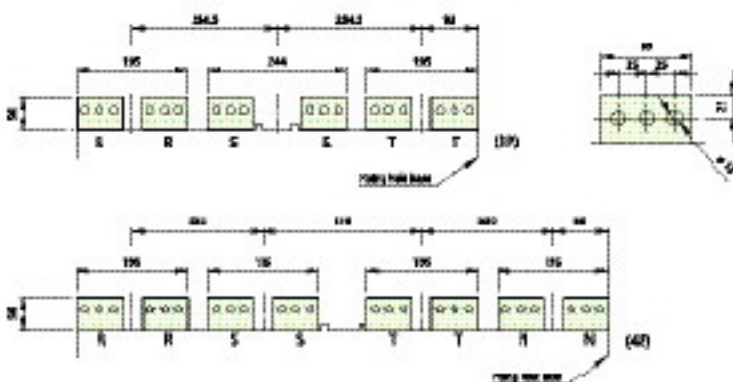
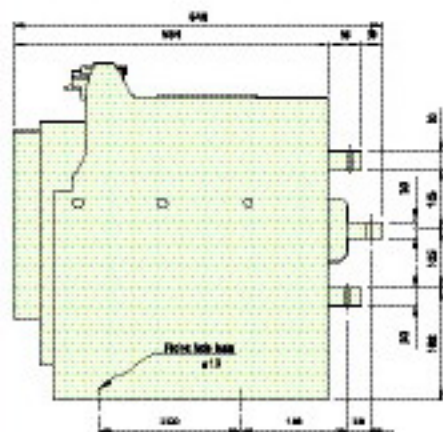



Circuit Diagram (회로도)

AC 110V, AC 220V

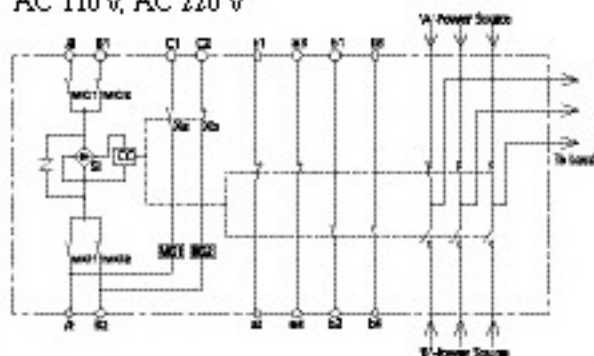

DC 110V, DC 125V

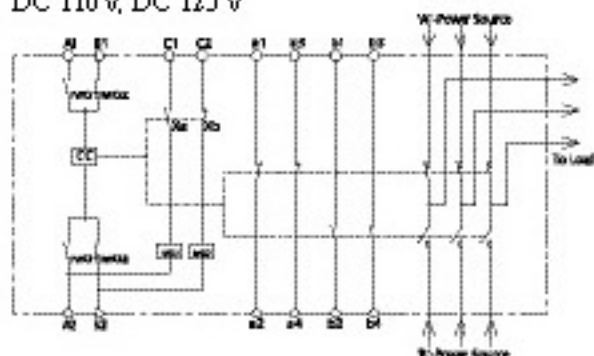

A1, A2	A-Power Closing Terminal	AX, BX	Control Switch
B1, B2	B-Power Closing Terminal	MG1, MG2	Magnetic Coil
CC	Closing Coil	a1, a2, a3, a4	A-Power Aux Switch
Si	Silicon Rectifier	b1, b2, b3, b4	B-Power Aux Switch

Typical Operating Circuit (대표적 조작회로 예)

Standard
(일반적인 접제)

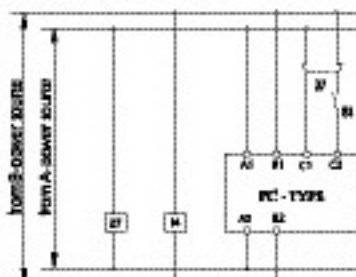

In case of using a changeover switch
(수동-자동 접제)

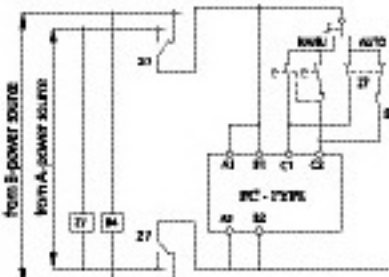

In case of using a timer
(타이머를 이용한 접제)

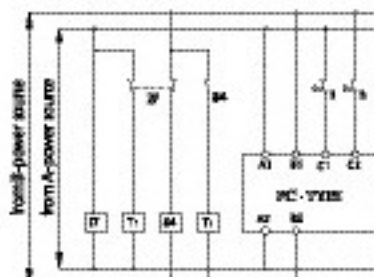

Wiring Diagram (결선도)

AC Operating and Control

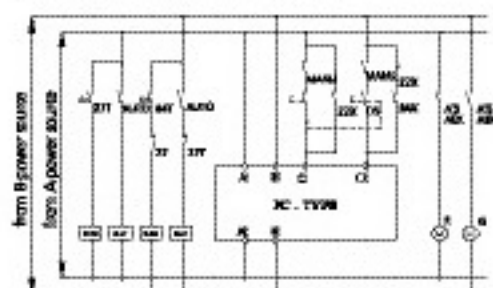

DC Operating and Control

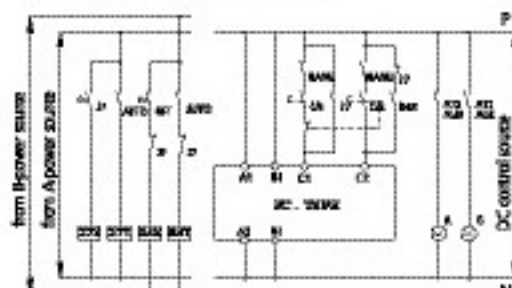

27X	Source-A Operating Relay	84X	Source-B Operating Relay
27T	27X Operating Delay Relay	84T	84X Operating Delay Relay
AUTO, MANU	Automatic, Manual	C/S	Control Switch

Caution : More than 2.0mm² power cable used for less than 1,600A ATS.
More than 3.5mm² power cable used for more than 2,000A ATS.



External View (외관명칭)

- ① B-power source indicating LED for Emergency (비상전원 표시 LED)
- ② A-power source indicating LED for Utility (상용전원 표시 LED)
- ③ ATS A-power transfer status indicating LED (ATS 상용전원측 절체 표시 LED)
- ④ SYC(In-phase Monitor) indicating LED (동기절체 표시 LED)
- ⑤ Selection switch of A-power source (상용전원 선택스위치)
- ⑥ Selection switch of B-power source (비상전원 선택스위치)
- ⑦ ATS B-power transfer status indicating LED (ATS 비상전원측 절체 표시 LED)
- ⑧ Selection switch of automatic or manual (자동, 수동 선택스위치)

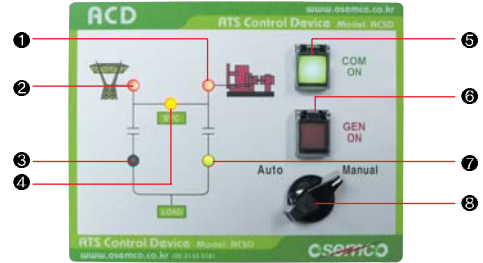

Specification

- Rated operating voltage : 220VAC
- Frequency : 50 / 60Hz
- Contacts capacity for ATS control : AC250V, 10A (No-load contacts)
- Contacts capacity for Abnormal power source : AC250V, 10A (No-load contacts)
- Fitment : Front Type

Basic Function

- Automatic or manual ATS control
- Built-in indicator for A-power (Utility), B-power (Emergency) and ATS transfer status
 - Power source : Red LED (Displayed when voltage is above 85%)
 - Transfer status : Green LED
- Manual operation buttons
 - For A-power(Utility) : Green
 - For B-power(Emergency) : Red
 - Note : Built-in LED is on for selective button
- Setting for automatic transfer time
 - Time setting at rear side to avoid unnecessary setting change
 - Variable time settings (0~30sec)
- While timer is working, indicating lamp for transferable ATS is flickered
- Detection for open phase of Utility power source (For 3ø4W, 220/380VAC only)
- Detection for power failure, and low voltage of Utility source and engine starting contacts provided against abnormal condition

In-phase Monitor Option

- On & Off of In-Phase Monitor can be selected by selection switch
 - When In-Phase Monitor is selected, Transfer is made manually or automatically when synchronized.
 - When In-phase Monitor is not selected, synchronizing indication lamp is not on.
- When synchronized, Yellow LED is flickered.
- When synchronized more than 3 cycles, Transfer will be made.
- When button for Utility or Generator will be selected under manual mode, Built-in LED is flickered until synchronizing.

Ordering Information

- ACD21 (ATS control device) : Basic Function
- ACSD (ATS control synchronizing device) : Built-in In-phase Monitor

기본사양

- 동작 전압 : 220VAC
- 주파수 : 50 / 60Hz
- 절체 출력접점 용량 : AC 250V 10A(무 전원 접점)
- 상전 이상 출력(발전기 기동 신호) 보조접점용량 : AC 250V 10A(무 전원 접점)
- 부착 방식 : 전면 부착

기본기능

- ATS를 자동 또는 수동으로 전환기능
- 상용전원과 비상전원의 표시와 전환상태 표시기능
 - 전원표시 : 적색 LED (전원이 85%이상 입전시 표시)
 - 전환상태표시 : 녹색 LED
- 수동 조작 버튼의 구성
 - 상용전원 선택버튼 : 녹색
 - 비상전원 선택버튼 : 적색
 - 선택이 가능한 버튼은 내장된 LED가 점등
- 자동 절체시간의 설정기능
 - 후면에서 시한 설정 (임의 조작방지)
 - 설정시간은 가변 설정(0~30초)
- TIMER 동작 중에는 절체 될 ATS 상태표시등을 점멸
- 상용전원의 결상 감지기능
 - 3상 4선식 380/220V에만 적용
- 상용전원의 정전 및 결상, 저전압 등을 감지하고, 이상시 발전기 기동신호 출력

동기절체기능 Option

- 선택 스위치에 의해 기능을 ON-OFF 기능
 - 동기기능 선택 시 수동, 자동 모두 동기일 때만 절체
 - 동기기능을 사용 하지 않을 경우에는 동기 램프는 점등 되지 않음
- 동기(SYC)시 황색 LED가 점멸
- 동기는 3주기 이상 동기가 일치될 경우 절체
- 수동모드에서 상용 또는 비상전원 선택버튼을 누르면 동기를 기다리는 동안 선택버튼에 내장된 LED가 점멸

주문 방법

- ACD21 (ATS control device) : 기본 기능
- ACSD (ATS control synchronizer device) : 동기절체 기능 내장



Wiring Diagram

3Ø4W 380/220V

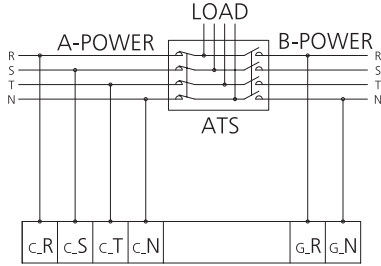

3Ø4W 220/127V

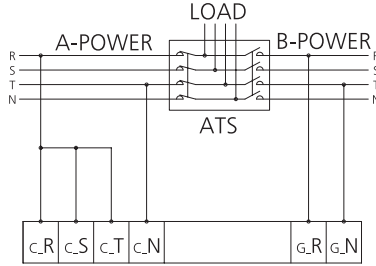

3Ø3W 220V

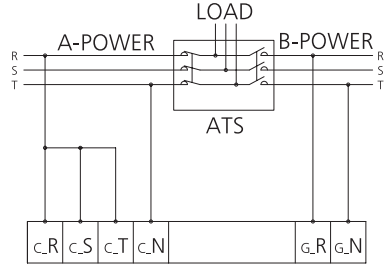

OSS II - T, TB Type

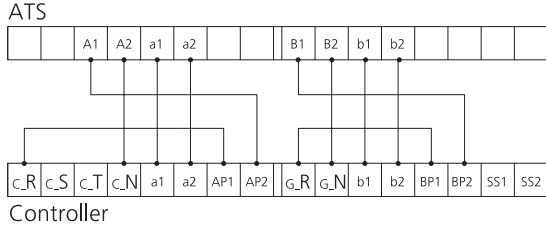

OSS - TN, TBN Type

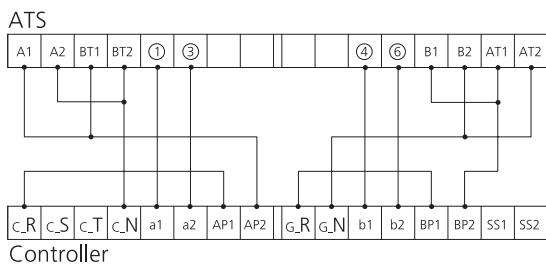

OSS - PC Type

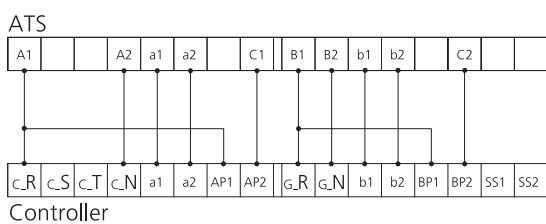

MODEL	G_R G_N b1 b2 BP1 BP2 SS1 SS2
<input type="checkbox"/> ACD21 <input type="checkbox"/> ACSD	발전전원 220V ATS발전측 보조 a접점 ATS발전측조작 무전압접점 발전기 기동신호
ATS CONTROL DEVICE	
ADJ1: 자동시 상원측 투입 지연 시간(0~30sec) ADJ2: 자동시 비상원측 투입 지연 시간(0~30sec)	상용전원(380/220V) ATS상원측 보조 a접점 ATS상원측조작 무전압접점
S/N: _____ I/P: _____	c_R c_S c_T c_N a1 a2 AP1 AP2 G_R G_N b1 b2 BP1 BP2 SS1 SS2

C_R~C_N	A-power source (상용전원)
G_R G_N	B-power source (비상전원)
AP1, AP2	Operating signal of ATS A-power side (ATS 상용전원측 절체 신호)
BP1, BP2	Operating signal of ATS B-power side (ATS 비상전원측 절체 신호)
a1, a2	Aux a contacts of ATS A-power side (ATS 상용전원측 보조 "a" 접점)
b1, b2	Aux a contacts of ATS B-power side (ATS 비상전원측 보조 "a" 접점)
SS1, SS2	Starting signal of Generator (발전기 기동 신호)
ADJ1	Delayed time setting of Utility side under Auto (0~30sec) (자동시 상용전원측 투입시간 지연)
ADJ2	Delayed time setting of Emergency side under Auto (0~30sec) (자동시 비상전원측 투입시간 지연)
SYC, S/W	ON/OFF selection of In-phase Monitor (Option) (동기절체기능 ON/OFF 스위치)

PANEL CUTTING

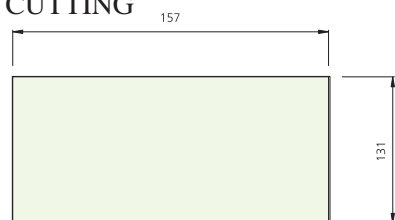

unit : mm



■ Standard Operating Conditions (표준사용환경)

- Ambient Temperature: -5°C~+40°C (but, the average temperature for 24 hours shall be lower than +35°C)
- Altitude: Below 2000m
- Environmental conditions
- Relative humidity shall be less than 85% at max. temp. +40°C, less than 90% at 20°C
- It shall not be allowed to use or store within the area of petrochemicals, ammonia, and corrosive gas.
- Storage Temp.: -20°C~+60°C (but, the average temperature for 24 hours shall be lower than +35°C)
- 주위온도 : -5°C ~ +40°C (단, 24시간 평균온도가 +35°C이하)
- 표고 2000m이하
- 환경조건
- 최대온도 +40°C에서 상대습도 85%이하, 20°C에서는 90%이하
- 유화, 암모니아 및 부식성가스 범위에서는 사용 또는 보관 불가 (H₂S ≤ 0.01ppm, SO₂ ≤ 0.01ppm, NH₃ ≤ a few ppm)
- 보관온도 : -20°C ~ +60°C (단, 24시간 평균온도가 +35°C 이하)

■ Applicable current by the temperature (온도별 사용전류)

In the case of using under the environment with over than 40°C, please adjust rated current as follows.

기준 주위온도인 40°C를 넘는 환경에서 사용하는 경우는 아래 표와 같이 정격전류를 보정하여 사용하여 주시기 바랍니다.

(Unit / 단위 : Ampere)

Rated current Ambient temperature	630A	800A	1000A	1250A	1600A	2000A	2500A	3150A	4000A	5000A
40°C	630	800	1,000	1,250	1,600	2,000	2,500	3,150	4,000	5,000
45°C	630	800	1,000	1,250	1,600	2,000	2,500	3,150	4,000	5,000
50°C	630	800	1,000	1,250	1,600	2,000	2,500	3,150	4,000	5,000
55°C	630	800	1,000	1,250	1,550	2,000	2,450	3,000	3,900	4,850
60°C	630	800	1,000	1,200	1,500	2,000	2,350	2,900	3,750	4,700
60°C ~ 100°C	315	400	500	630	800	1,000	1,250	1,575	2,000	2,500

Note) IEC 60947-1 Standard is applied to the data for 40°C. 주) 주위온도 40°C의 Data는 IEC 60947-1의 규격을 적용하였습니다.

■ Bolt tightening torque(for nut) (볼트 체결 토크 (너트의 경우))

Class : 8.8

	M4	M5	M6	M8	M10	M12	M16	M20
Torque(N.m)	2.5~3.2	5.0~6.3	8.7~10.9	21.1~26.4	41.6~52	71.6~89.5	177.6~222	358.4~448

■ Selection of TR Capacity

TR capacity should be selected more than the value calculated by the following formula.

Operation Voltage x Operation Current x 0.5 = ()VA

e.g.) Operation Voltage AC 220V, Operation Current 4A

220 x 4 x 0.5 = 440VA, TR capacity of more than 440 VA is recommended.

■ Selection of Control Relay

Voltage Relay 27, 84 and Timer are required to select so that its contact capacity are higher than ATS operation current.

Considering chattering of Control Relay, it is safer to select the relay which can break operation current.

Note: If the operating power source is unstable, Voltage setting relay is recommended to use.

■ 조작용 TR용량 선정

조작회로용 TR용량은 하기 계산식에 의한 계산치 이상의 용량을 사용하여 주십시오.

조작전압 x 조작전류 x 0.5 = ()VA

예) 조작전압 AC220V 조작전류 4A

220 x 4 x 0.5 = 440VA

440VA 이상의 TR을 사용하여 주십시오.

■ 제어 Relay의 선정

전압 Relay 27, 84 및 Timer는 접점 통전전류가 ATS조작전류 이상의 것을 사용하여 주십시오. 제어 RELAY의 Chattering 등을 고려하여 조작전류의 차단이 가능한 Relay를 선정하여 사용하시면 보다 안전합니다.

주) 조작전원이 불안정한 경우에는 전압확립 Relay를 사용하여 주십시오.

Doc No.: KTI03EC05001

EC Declaration of Conformity

O-Sung Electric Machinery Co., Ltd.

We, #111-3, Youngtae-Ri, Woollong-Myun, Paju-City, Kyungki-do, Korea
declare under our sole responsibility that the products:

Product : ATSE(Automatic Transfer Switching Equipment)
Model No.: SS-62-TN

The product identified above is tested by the requirements of the EU Directives of the following standards:

Related standards for Electromagnetic Compatibility Directives 86/336/EEC

EN 60947-6-1: 1991
+A2: 1997

EN 60947-6-1: 1991
+A2: 1997

Low-voltages switchgear and controlgear-
Part-6-1: Multiple function equipment-
Automatic transfer switching equipment

Above described products are fully complying with the essential requirements of the EU directives. But, the test report in accordance with EMC directive and others are additionally required, if need.

Issued date: May 02, 2003

Tested by:

Korea Technology Institute Co., Ltd.

G C Min

Ph.D Gyung Chan, Min / President

Manufactured by:

O-Sung Electric Machinery Co., Ltd.

H.B. Moon / President

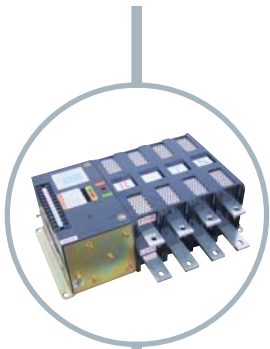

O-Sung Electric Machinery CO., LTD.

五星機電株式會社

Head Office & Factory

111-3, Youngtae-Ri, Woollong-Myun, Paju-City, Kyungki-Do, Korea

Tel : (82-31)944-3521/3, (82-2)332-6151

Fax : (82-31)944-3525, (82-2)332-6152

Website : <http://www.osemco.com>

E-mail : osemco1@korea.com, ousung@chol.com

본사 / 공장

경기도 파주시 월롱면 영태리 111-3

Tel : (031)944-3521/3, (02)332-6151

Fax : (031)944-3525, (02)332-6152

Website : <http://www.osemco.com>

E-mail : osemco1@korea.com, ousung@chol.com

Catalog No. ATS - 0603

※ Information in this catalog may be changed without prior notice in view of continued development.

※ 본 제품의 사양은 제품의 품질향상 목적으로 예고없이 변경될 수 있습니다.